



GROUP

QUALITY OVER THE SEA



CRUISE
TECHNICAL DIVISION



YACHT
TECHNICAL DIVISION



MILITARY
ADVANCED SOLUTIONS



TECH
HVAC & REFRIGERATION



PAINTING
CHIPPING & PAINTING



NANOTECH
NANOTECHNOLOGIES



LAB
R&D DIVISION

Multi-disciplinary onboard
and shipyard services for
the marine industry





RC®
MARINE

GROUP

QUALITY OVER THE SEA













We are an Italian company that provides in the world on-board and shipyard multi-disciplinary services for hvac and refrigeration, nanotechnologies, chipping and painting, research and development. We work for the main players of the naval industry since 2009 and we offer a wide range of turnkey solutions dedicated to cruise ships, yachting and military branches.

We have all the necessary certifications to work on refrigeration systems, air conditioning and heat pumps, and we help our customers to navigate safely with a 24/7/365 worldwide assistance service in shipyard and in navigation.



Our seven departments

We are organized in seven departments, each one with a specific know-how dedicated to the different needs of our customers. As group, we grant a high quality multi-disciplinary knowledge at your disposal and a wide range of turnkey solutions for design, optimize, install and maintain.

	<p>CRUISE <small>TECHNICAL DIVISION</small></p>		<p>Project Management with specific know-how and expertise in different market segments</p>
	<p>YACHT <small>TECHNICAL DIVISION</small></p>		
	<p>MILITARY <small>ADVANCED SOLUTIONS</small></p>		<p>Advanced HVAC systems customization and multi-disciplinary development for the military sector.</p>
	<p>TECH <small>HVAC & REFRIGERATION</small></p>		
	<p>PAINTING <small>CHIPPING & PAINTING</small></p>		<p>Three technical departments specialized in hvac and refrigeration, chipping and painting, nanotechnologies.</p>
	<p>NANOTECH <small>NANOTECHNOLOGIES</small></p>		
	<p>LAB <small>R&D DIVISION</small></p>		<p>Research and development, acoustic and vibrational design, fluid-dynamics and thermo-structural analysis.</p>



RC®

MARINE

CRUISE

TECHNICAL DIVISION



RC Marine | Cruise Division

Since 2009 we are [partners](#) and [suppliers](#) of the global major cruise groups, providing on-board and shipyard services and 24/7 [worldwide assistance](#). Expertise and [multi-disciplinary](#) know-how are our distinctive elements.

[Project Management](#) and [Turnkey Solutions](#) are focused on taking care of a market segment where the ability to balance the scaling dynamics with the quality of supplies is [fundamental](#).





RC®
MARINE

YACHT

TECHNICAL DIVISION



RC Marine | Yacht Division

We provide installation of systems, on-board and shipyard services dedicated to the world of [quality boating](#) and [yachts](#). Experience and [multi-disciplinary](#) know-how are our distinctive elements.

[Project Management](#) and [Turnkey Solutions](#) are focused on the [quality](#) of the components and services offered, guaranteeing expertise and maximum flexibility in customizing the installations.





RS®
MARINE

MILITARY
ADVANCED SOLUTIONS



RC Marine Group Military Division performs the design and customization of plants and on-board systems in order to guarantee the maximum reliability in a environment that does not allow mistakes. We have specialized our in-house skills in the customization of hvac systems dedicated to weapon systems and nbc equipments.



The logo consists of the letters 'R' and 'T' in a bold, black, sans-serif font. The 'R' has a horizontal orange bar across its middle. A registered trademark symbol (®) is located to the upper right of the 'T'.

RT®

MARINE

TECH

HVAC & REFRIGERATION



Since 2009 we supply the companies **leaders of the naval sector** with a 24/7 global service for shipyard and onboard assistance on all types of hvac systems.

Our **24/7 global assistance** service includes: inspections and **troubleshooting**, overhauling and preventive maintenance, repairing and full unit replacements, system design and **installation**, painting and insulation of technical stations, energy optimization, installation of automation systems, testing, verification and **balancing**.



HEINEN & HOPMAN



RC Marine Group S.r.l. Unipersonale
 Office: Francesco Rolla 18a, 16152 Genova
 Workshop: Via Molo Cagni, 16128, Port of Genova
 Worldwide 24/7 Assistance +39 340 827.53.07
 Customer care +39 010 859.26.42
 www.rcmarine-group.com
 VAT No. IT01905060990



GROUP

QUALITY OVER THE SEA



Since 2009 we supply the companies **leaders of the naval sector** with a 24/7 global service for shipyard and onboard assistance on all types of refrigeration systems.

Our **24/7 global assistance** service includes: inspections and **troubleshooting**, overhauling and preventive maintenance, repairing and full unit replacements, system design and **installation**, painting and insulation of technical stations, energy optimization, installation of automation systems, testing, verification and **balancing**.





In our inspections we check circuits and components that show any risk of leaking using proper detection devices.



We use certified leak detector with at least a 5g/year sensibility and a proprietary bubble solution/soapsuds.



Nitrogen pressing of the circuit, just in case of leaks undetected neither by soapsuds nor by the leak detector device.



Here is an example of **refitting** of the **piping insulation** of a refrigeration facility. In order to increase as maximum as possible the piping lifetime we provide a **turnkey service** that includes: chipping, first painting, second painting, insulation with armaxflex and then another painting over it to increase its resistance and lifetime.





RC®
MARINE

PAINTING
CHIPPING & PAINTING



Since 2009 RC Marine Painting division provides painting, insulation and **naval flooring** services for internal rooms and technical stations. Our turnkey service includes **chipping and cleaning** the floor, use of MAD Defense to **prevent corrosion**, painting the floor with MAD Shark, painting the **Armaflex insulation** with MAD Armor.





Our **turnkey service** for external **decks and machinery** includes: chipping and cleaning the corrupted surfaces, **MAD Bond** applied to stop corrosion, **MAD Fiber** applied to restore damaged areas, painting the decks with **MAD Shark** non-skid, painting of machinery and bulkheads with **MAD Armor**.





Our **turnkey service** for external **intakes** includes: chipping and cleaning the corrupted surfaces, **MAD Bond** applied to stop corrosion, **MAD Fiber** applied to restore damaged areas, painting the intakes with **MAD Armor**.





NANOTECH
NANOTECHNOLOGIES

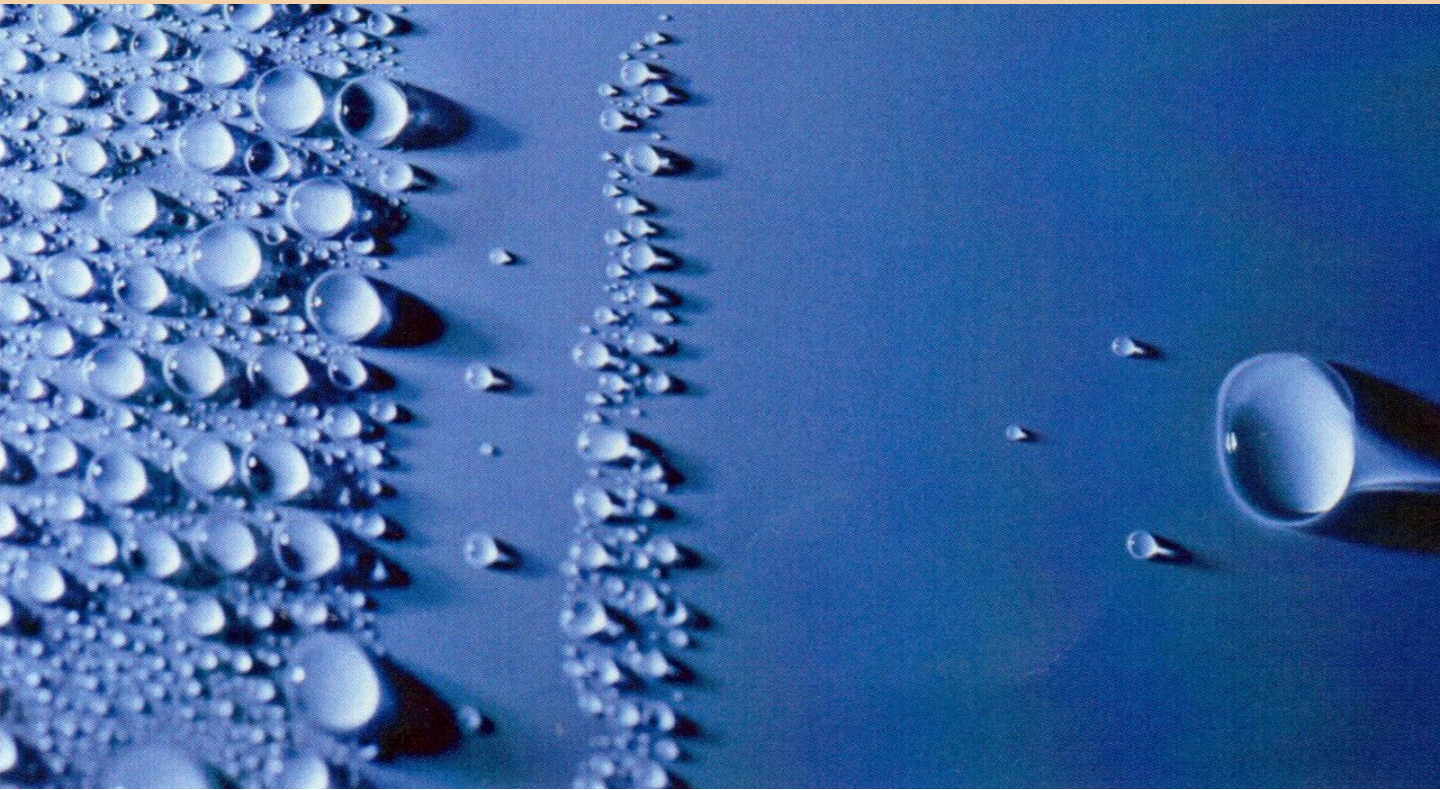

Conserve, protect, clean and hygienize

4 advantages made by the **application of nanotechnology** that allow a saving of times and costs of cleaning and maintenance.

What is Nanotechnology and how it works

It consists in the vaporization of a layer of **ceramic nanopigments** on any surface, it's totally environmentally friendly and produces evident results mainly in three specific areas: the protection from **corrosive agents**, the inhibition of the deposit of **liquids and dirt** and the sanitization for the reduction of the **presence of pathogens** and infectious risk thanks to the **photocatalysis** process.

We are specialized in nanotechnologies and execute treatments which allow to increase the **performance** and the operational **life cycle** of glasses, on-board equipment, passengers cabins, toilets and kitchens.



Glasses and crystals

The treatment with **ceramic nanopigments** makes each crystal **super-hydrophobic** and **water-repellent** and guarantees the flow of liquids without any residue for impact angles superior to 150°.



Screens and equipment

Increases the **scratch resistance** of screens and equipment, guarantees repellency to liquids, inhibits fouling and oxidation, generates **self-cleaning surfaces** that inhibit the **deposit of dirt**.



Passenger cabins

In the cabins every object or surface is **subject to contamination**. The nanotechnological treatment **sanitizes** the main **starting points** such as toilets, carpets, curtains, bedspreads and areas that are difficult to clean.



Bathrooms and kitchens

In environments where **hygiene is essential** as kitchens, bathrooms and operating rooms, the treatment **ensures** that bacteria, viruses, fungus, spores are eliminated by **molecular decomposition**.



RC®
MARINE

LAB
R & D DIVISION

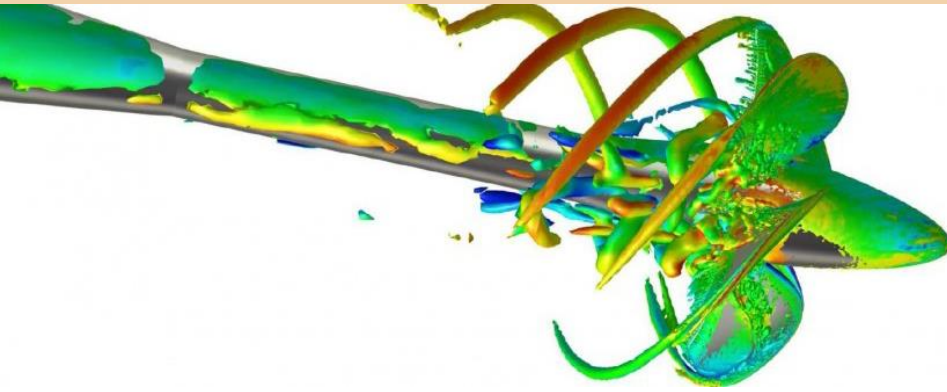

Acoustic CFD Design

Prevent **noise and vibrations** by studying these phenomenon during the product development phase will reduce **time to market** and **future failures**. We evaluate the excitation structure based on acoustic sources, unstable pressure fields and points applied to the vibrating structure.

Who: Technical office

What: CFD analysis and redesign

Why: Noise and vibrations

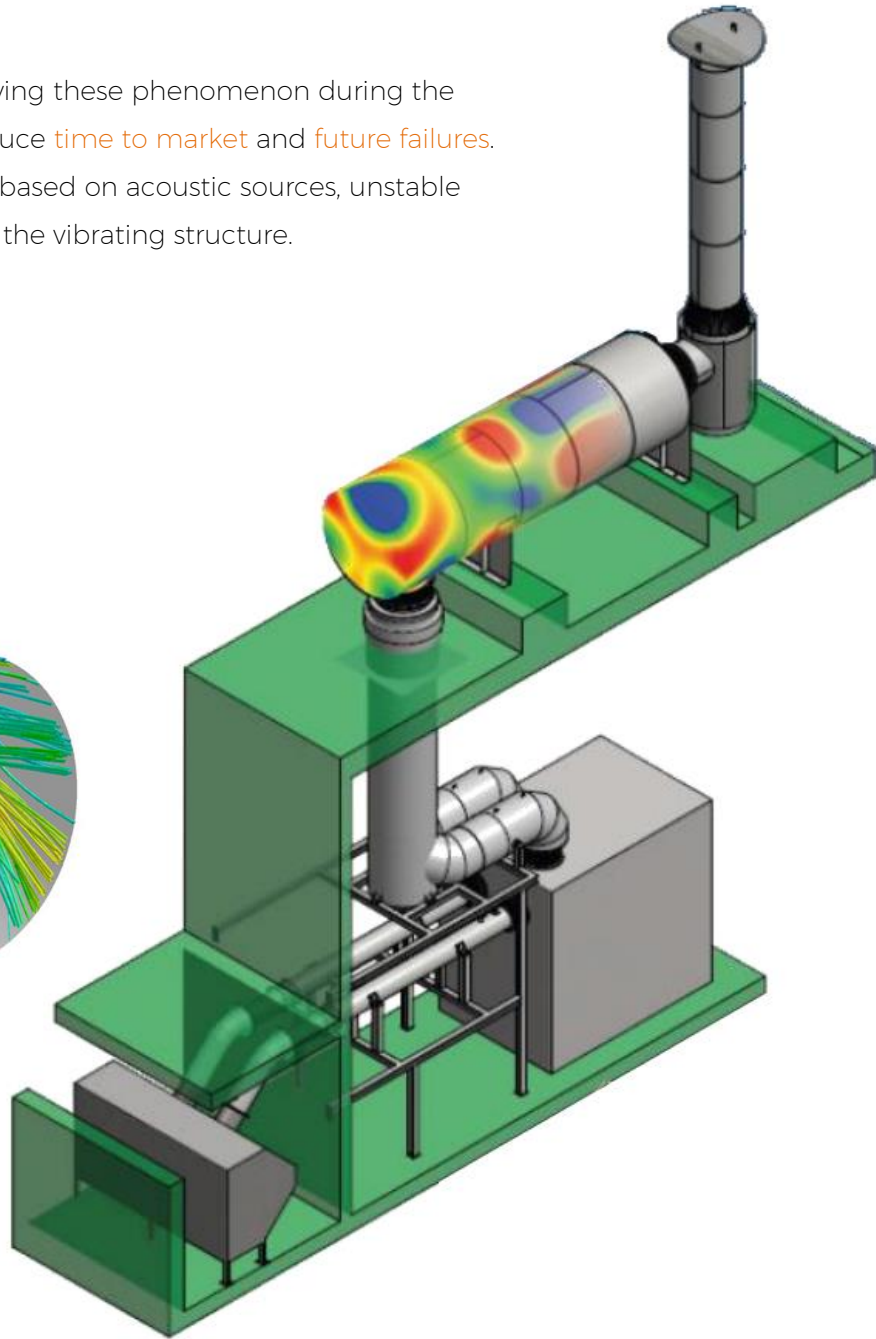
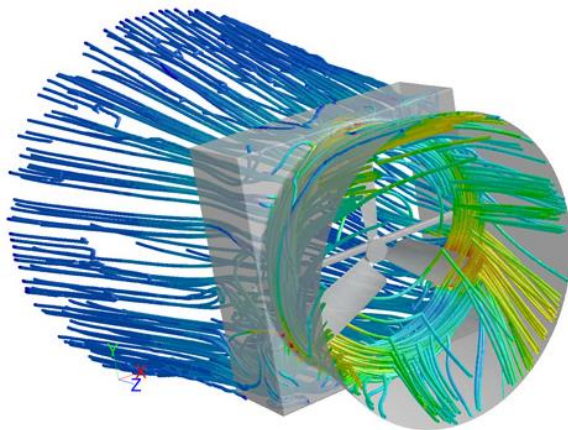

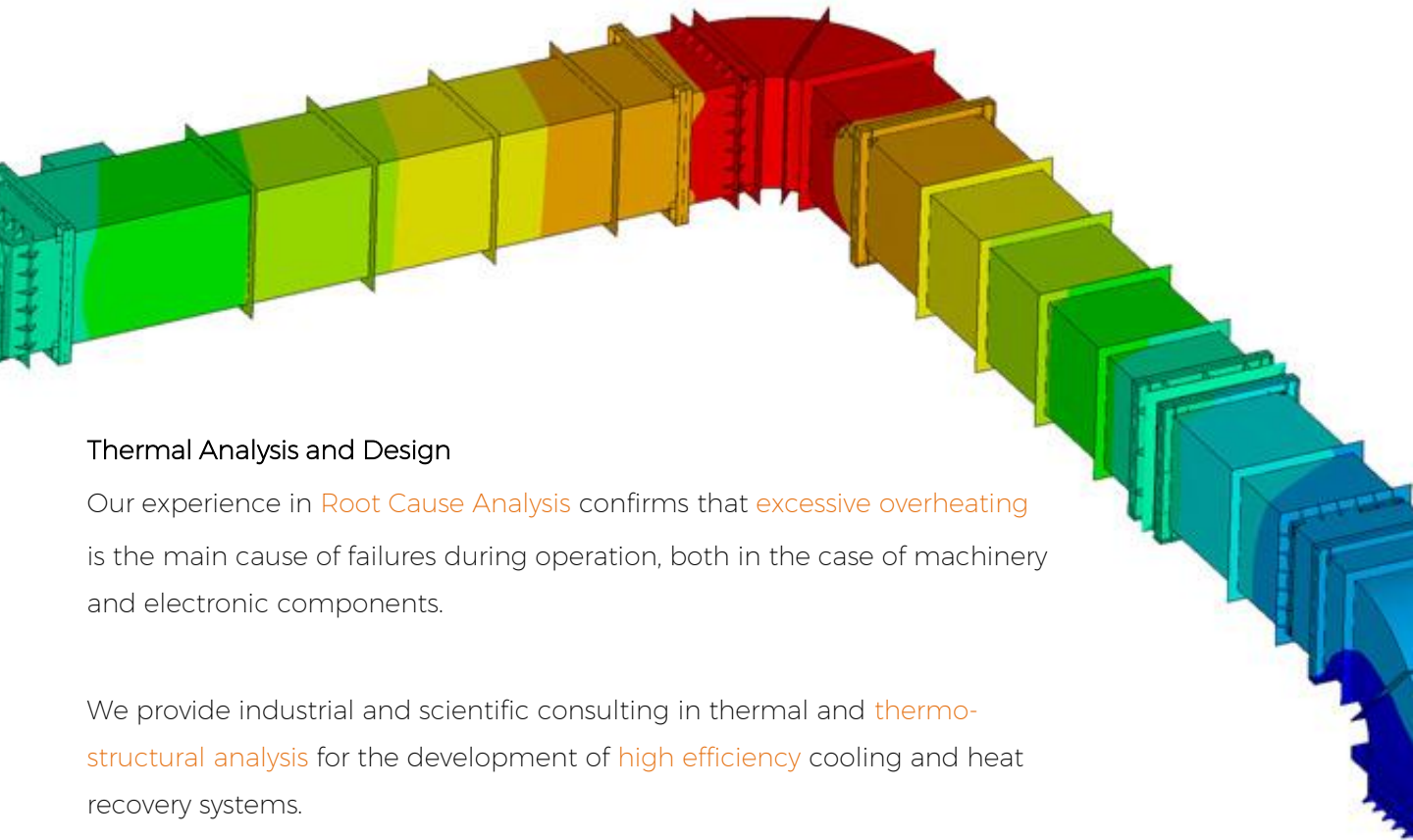

Thermal Analysis and Design

Our experience in **Root Cause Analysis** confirms that **excessive overheating** is the main cause of failures during operation, both in the case of machinery and electronic components.

We provide industrial and scientific consulting in thermal and **thermo-structural analysis** for the development of **high efficiency** cooling and heat recovery systems.

Who: Technical office

What: CFD analysis and redesign

Why: High thermal loads

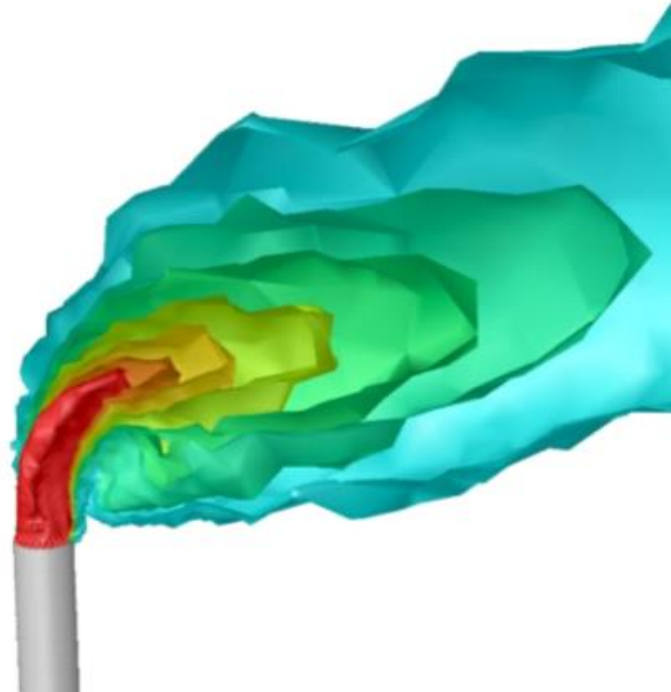
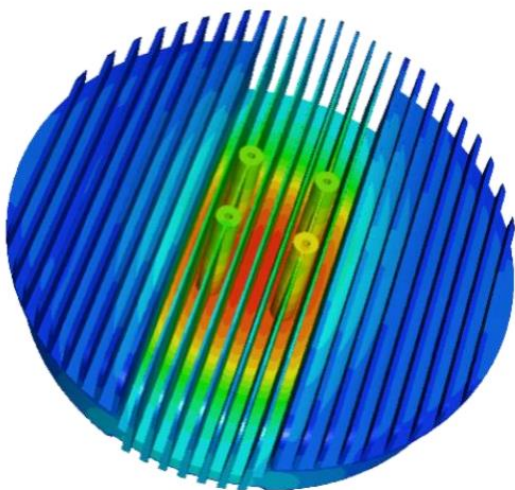

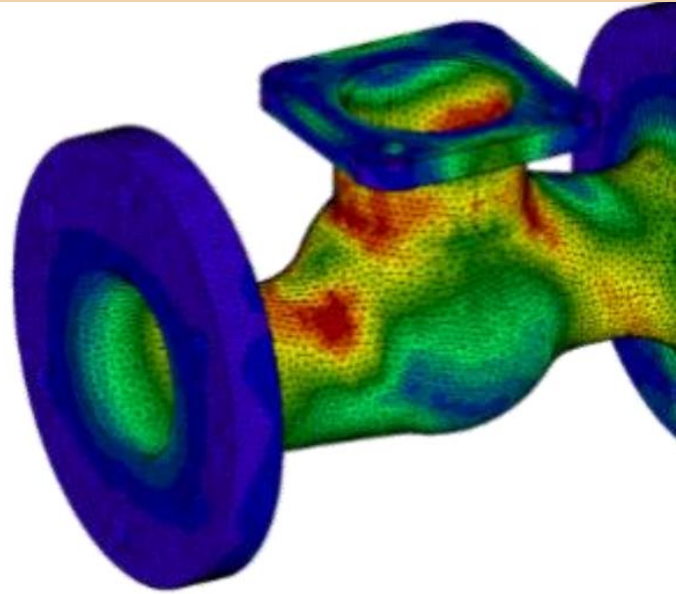

Mechanical Design

The **Finite Elements** structural analysis allows to study the behavior of structures and machines also very complex, subdividing them into many **small elements** that can be easily calculated.

We can test **innovative solutions** on your product, predict its behavior and optimize its characteristics even before the **prototyping phase** and the first physical model test.

We are specialized in performing **structural calculations** for every type of turbomachinery and industrial components.

Who: Technical office

What: FEA analysis and redesign

Why: Mechanical failures or high stress fields

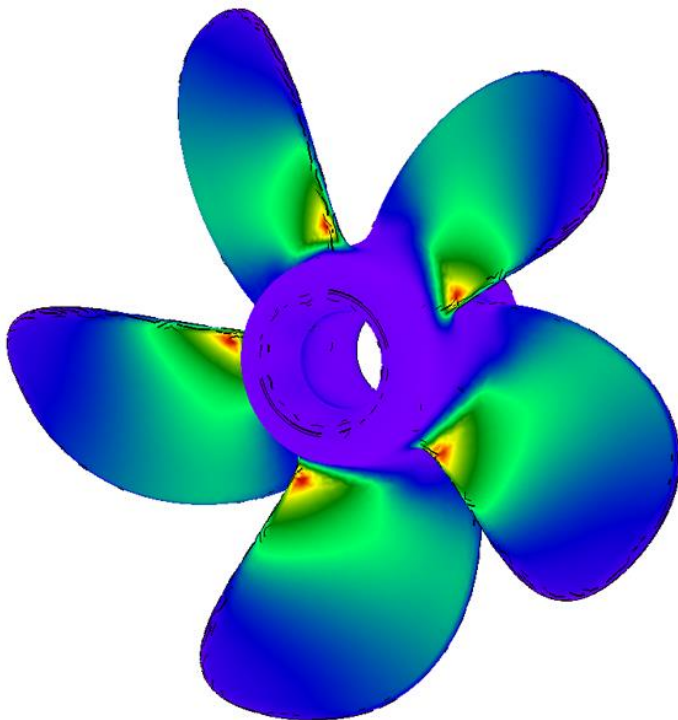

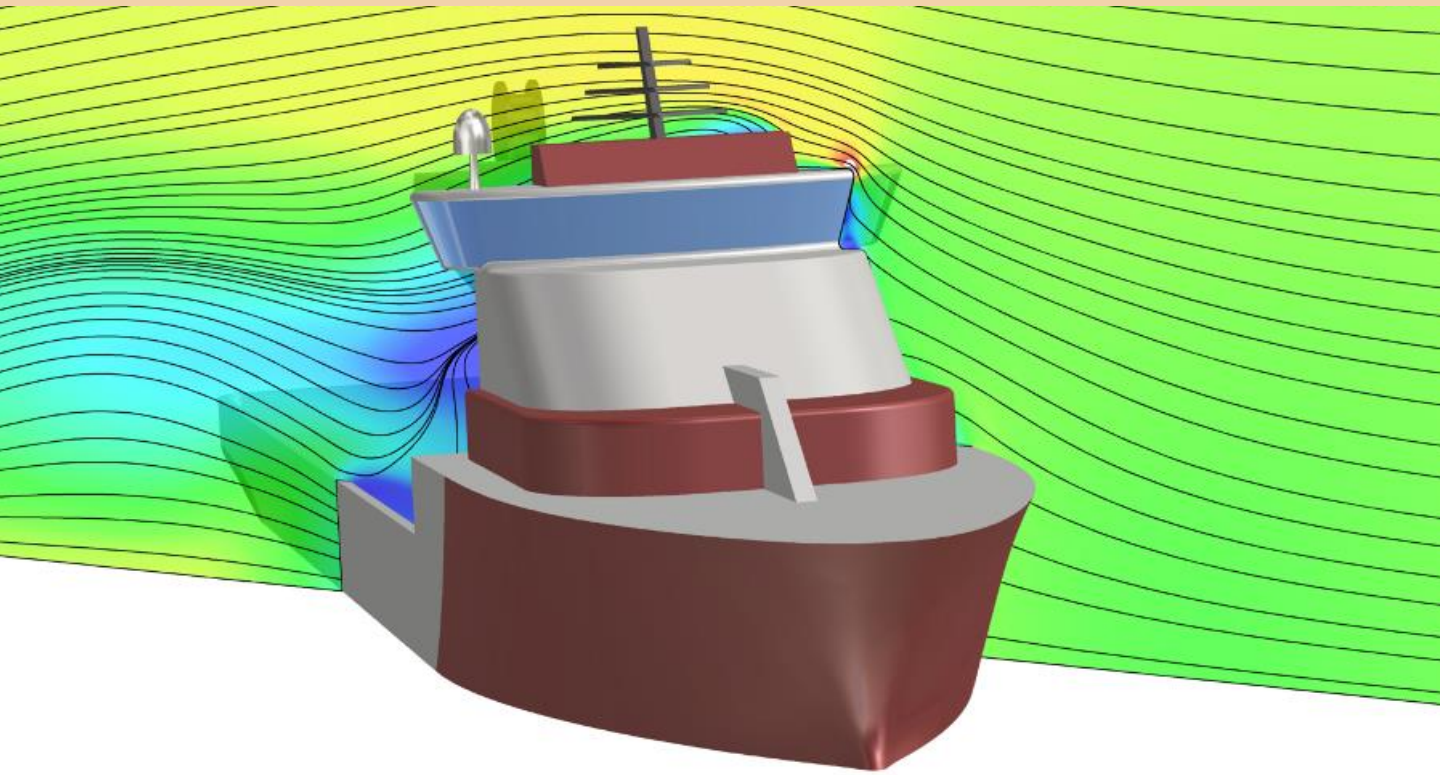

Computational Fluid-Dynamics Design

The **fluid dynamics** allows to analyze and **describe with high accuracy** common phenomena such as the interaction of fluids with solid structures, heat transmission, phase change and reactive phenomena such as combustion..

Who: Technical office

What: CFD analysis and redesign

Why: Lack of performance





RC®
MARINE

GROUP

QUALITY OVER THE SEA

1921  Ignazio Messina & C.

Ignazio Messina Lines | Genoa, Italy

- A/C and Refrigeration Plant System Service for all fleet



Rimorchiatori Riuniti Finarge | Genoa, Italy

- A/C System Service for all fleet.

FINCANTIERI

Fincantieri | Genoa , La Spezia, Riva Trigoso, Italy

- AIR CRAFT CARRIER CAVOUR: Refrigeration Plant Installation.
- M/Y SERENA: Refrigeration Plant Installation and Commissioning
- FREMM PROGRAM (4 Ships): New Installation Refrigeration Plant and Commissioning Celtic Pacific Southampton (UK)
- SEVEN SEA NAVIGATOR: Refrigeration Plant Refitting, HVAC Systems
- SEVEN SEA VOYAGER: Refrigeration Plant Refitting, A/C Refitting Duct and AC Stations
- SEVEN SEA MARINE: Refrigeration Plant Refitting, A/C Refitting Duct and AC Stations



Costa Crociere | Genoa, Italy

- COSTA SERENA: Refrigeration Plant and A/C systems New Installation



Saipem Indonesia | Offshore

- IRAQ CRUDE OIL: Export Karimun Indonesia New Installation A/C System



Precetti inc. | M/N, USA

- INSIGNA: Refrigeration Plant New Installation, A/C Refitting Duct and AC Stations
- M/N NAUTICA: Installation 4 AHU A/C Systems and Calibration System
- M/N REGATTA: Refrigeration Plant New Installation



Carnival | Miami ,Florida, USA

- CARNIVAL ECSTASY: Supervision and Quality Control of Installations on HVAC Systems
- CARNIVAL ECSTASY: Replacement of Armaflex Insulation Compressors Provision Room
- CARNIVAL DREAM: Supervision and Quality Control of Installations on HVAC Systems
- CARNIVAL FANTASY: Supervision of Installation and Commissioning A/C Systems.
- CARNIVAL MAGIC: Supervision and Quality Control of Installations on HVAC Systems
- CARNIVAL SENSATION: Supervision and Quality Control of Installations on HVAC Systems
- CARNIVAL SENSATION: Replacement of Armaflex Insulation Compressors Provision Room
- CARNIVAL BREEZE: Supervision and Quality Control of Installation on HVAC Systems
- CARNIVAL BREEZE: Replacement of Armaflex Insulation Compressors Provision Room
- CARNIVAL TRIUMPH: Supervision and Quality Control of Installations on HVAC Systems



HEINEN & HOPMAN

Heinen Hopman | Netherlands

- M/Y ANDREAS: A/C Refitting Duct and AC Station
- M/Y MOONLIGHT II: Refrigeration Plant and A/C Refitting Duct and AC Station
- MINEHUNTER PROGRAM (3 ships): Finish Navy New Installation A/C and Commissioning
- MINEHUNTER PROGRAM (1 ship): Finish Navy New Installation A/C and Commissioning



V Ship | Monaco

- M/N ARMENIA: Refitting A/C System Duct and AC Station
- M/N ALBATROS: Refitting A/C System Duct and AC Station
- M/N ITALIA: ex Stockholm Refitting A/C System Duct and AC Station.



Callenberg | Sweden and Netherlands

- M/N ALICE: Magali,Goa,Victory,Hansaland, Service for refrigeration Plant and A7C System



Heinen & Hopman | Italy

- M/Y CAPELLA: Ac Station Refit, Supervision and Commissioning, project management
- M/Y YOU AND ME: Installation of a new AC Chilled Water Unit, Supervision, Commissioning
- MINEHUNTER PROGRAM: Installation of a new AC plant for algerian navy
- MY FOREVER ONE: Commissioning AC Plant (New Installation)
- MY LIONHEART II: Commissioning AC Plant (New installation)
- MY AKULA: Complete Refitting Provsion Cooling Plant
- MY QUEEN MAVIA: Complete Restoration and overhaul of main AC plant and PCP
- MY DEJA TOO: Complete Restoration and overhaul of main AC plant and PCP
- MY SEA DREAM: Pressure test of main AC plant, Restoration and retrofit
- MY SAGAMAR: Complete Restoration and overhaul of main AC plant and PCP
- MY ANTARES: Replacement of main sea water condenser and AC plant restoration
- MY SURPINA: Complete Restoration and overhaul of main AC plant
- MY ADAMAS III: Project Management, Engine Room Ventilation upgrade
- MY BARAKA: Complete Restoration and overhaul of main AC plant and PCP
- MY VIKY: Complete Restoration and overhaul of main AC plant
- MY SYLVER ANGEL: Project Management and refitting of main AC plant



GROUP

QUALITY OVER THE SEA

For further information please contact:

Luca Costanza

CEO RC Marine Group S.r.l.

luca.costanza@rcmarine-group.com

+39 340 827.53.07